

3D SIMO

MultiPro



User manual

Multifunctional tool for workshops and households

Presentation

Congratulations on your purchase of 3Dsimo MultiPro, a multifunction device that allows you to turn your creativity into reality. All you need to do for the start of your creation is to plug 3Dsimo MultiPro into the power supply, select the appropriate extension, insert it into the body of the device and follow the instructions on the screen of the device.

Before using the device, make sure that you have read the instructions for use with all the functions and risks associated with the use of 3Dsimo MultiPro. If there is any doubt on your side, visit our website or contact our technical support:

support@3dsimo.com

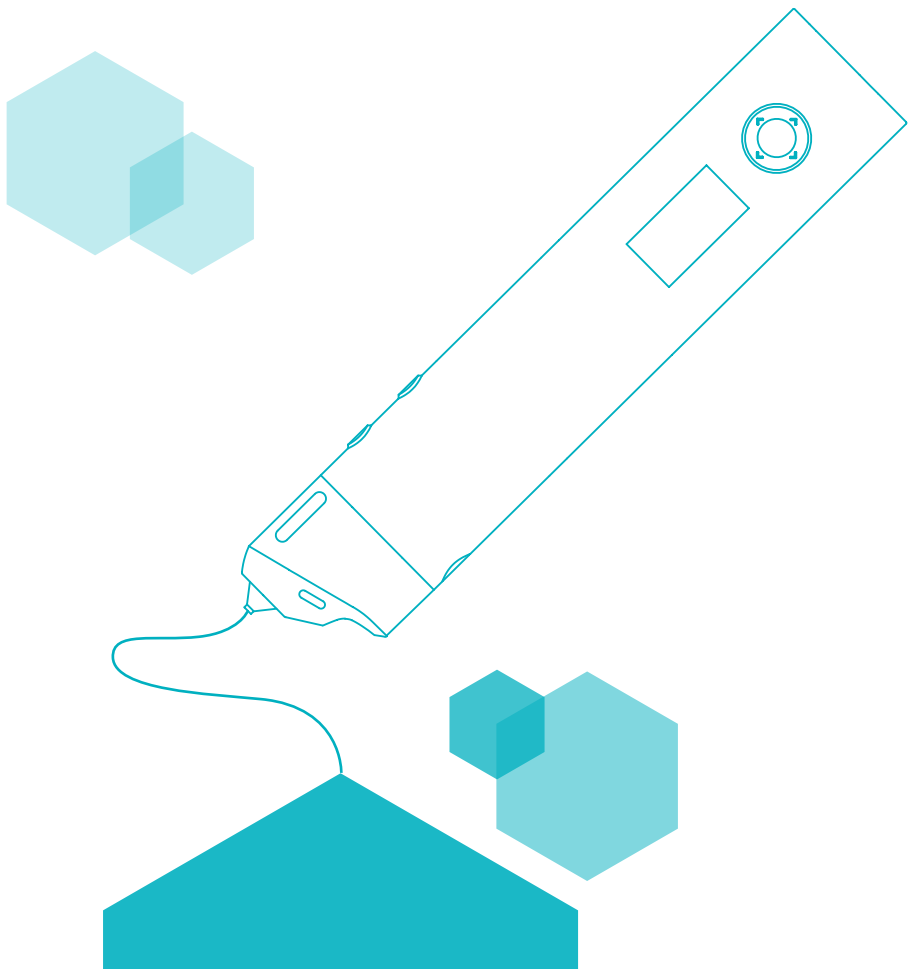

Contents of the package

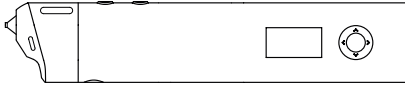

1× 3Dsimo MultiPro with extension for 3D drawing

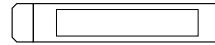

1× Soldering tin packaging

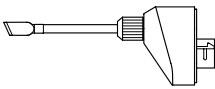

1× Burning extension

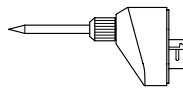

1× Soldering extension



1× Locking screw

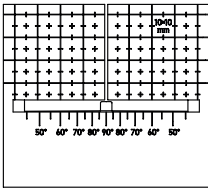

1× Platform for accurate angles

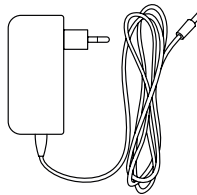

1× Power source



1× Coil of resistance wire

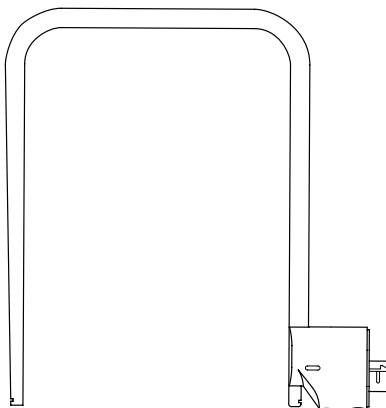

1× Foam cutting extension

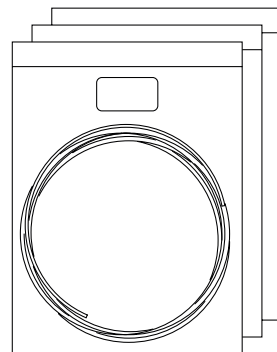

3D filament - 15 m

3Dsimo Multipro Controls

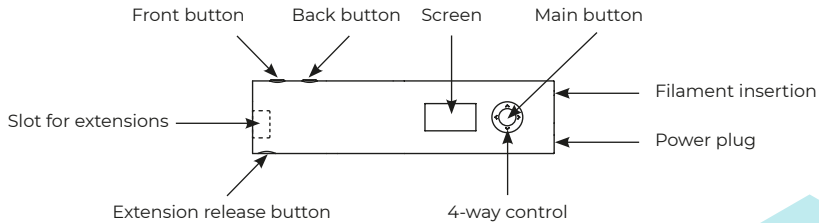

Language selection

1



In default settings press the main button.

2



This will take you there to the *Menu*.

3

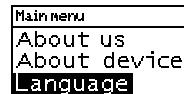

Scroll to *Language* and confirm with the main button.

4



Use the up and down arrows to switch to the appropriate language and confirm with the main button.

Starting of tutorial

1



In default settings press the main button.

2



This will take you there to the *Menu*.

3



Scroll down to *Tutorial* and confirm with the main button.

4

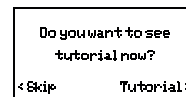

The option to run the tutorial is displayed, start it with the right arrow and follow the instructions.

Mobile app

The mobile app is available for devices with Android and iOS.

The 3Dsimo app allows you to update your device for future extensions, as well as lots of ideas and inspirations for your future projects using 3Dsimo MultiPro.

3Dsimo MultiPro uses a Bluetooth connection.

Replacement of extensions

Your 3Dsimo MultiPro already has an extension for 3D drawing attached after the first unpacking. To remove the extension, first press the attachment release button, then slide the extension out of the device.

To insert an extension, insert the selected extension into the device.

The extension will be recognized automatically.

If the extension was inserted for the first time, the instructions for using this extension will appear on the screen, after successful completion you can start using this extension to its full potential.

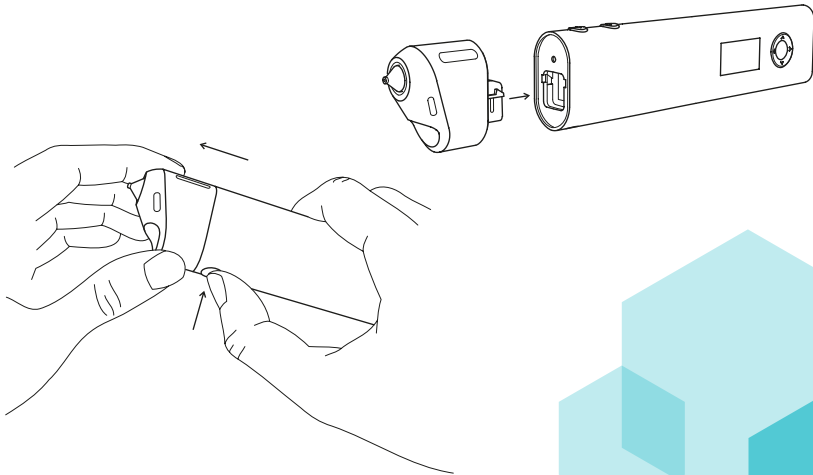

Extension for 3D drawing

After attaching extension for 3D drawing and successfully completing the tutorial, select the correct filament type. You can change the material profile using the 4-way control, pressing the left and right buttons. You can also select a filament insertion

speed using the up and down buttons. When READY appears on the screen, you can load material. When inserting the filament, it is necessary to push the filament while holding the button in front. After about 5 seconds, material begins to come out of the nozzle.

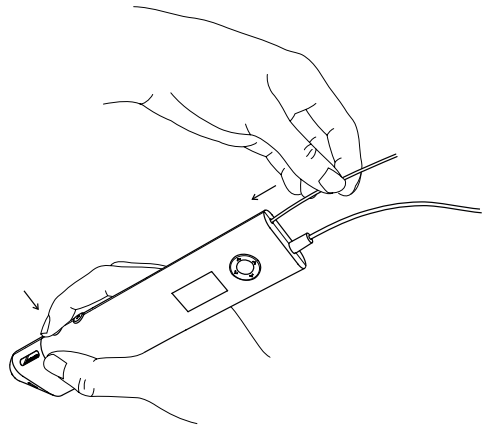
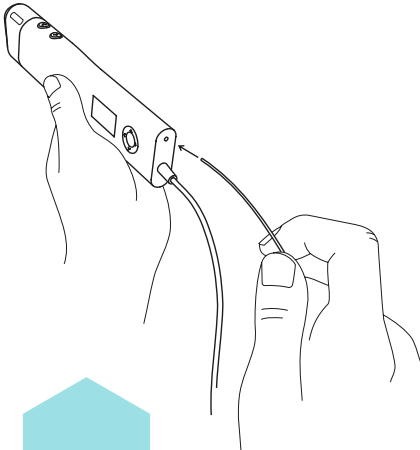
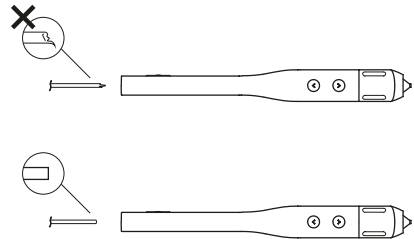
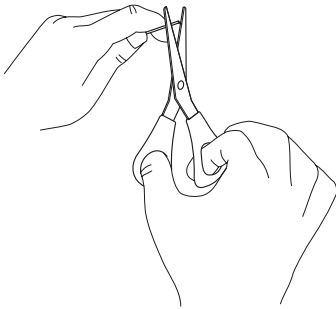

Continuous material printing is activated by pressing both buttons at the same time for about 5 seconds.

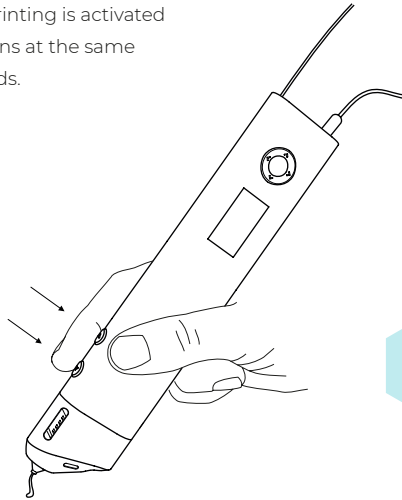

Configuration of your own material profiles

1

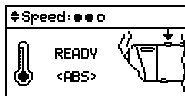

In default settings, press the main button.

2



This will bring you to the *Menu*.

3



Validate the *My profiles* option with the main button.

4



The option of the current extension is displayed, validate with the main button.

5



To create a new profile, move the down arrow to the *New profile* option and confirm with the main button.

6

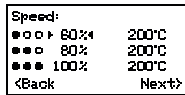

Set the name and use the down arrow to move to *Next* and the right arrow to access the speed and temperature settings.

7

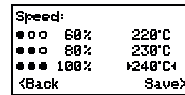

The options choice is selected with the main button. Control of the range and move on the screen is executed by arrows.

8



Foam cutting extension

Before the first use, it is necessary to stretch the resistance wire between the grooves at both ends of the attachment (see the image), insert the extension

into the 3Dsimo MultiPro, select the desired wire temperature (0 - 100%) and activate the extension heating by pressing the front button.

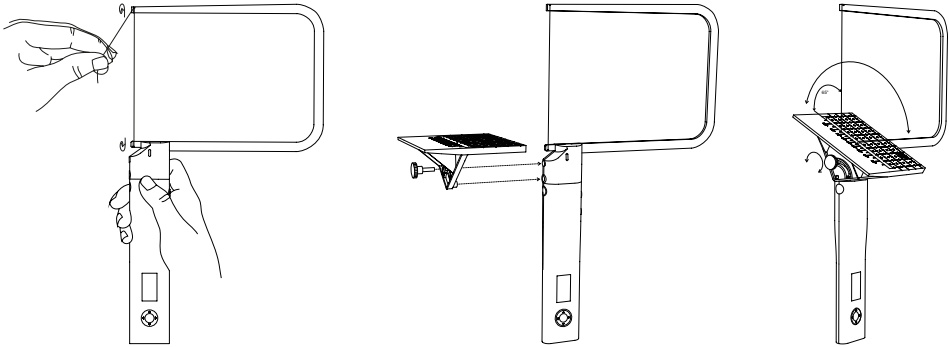

Burning extension

After attaching the extension to burn and successfully completing the tutorial, select the desired temperature of the tip (0 - 100%; 100% $\approx 500^{\circ}\text{C}$ / 932°F) and turn on the heater for the accessory by pressing the front button.

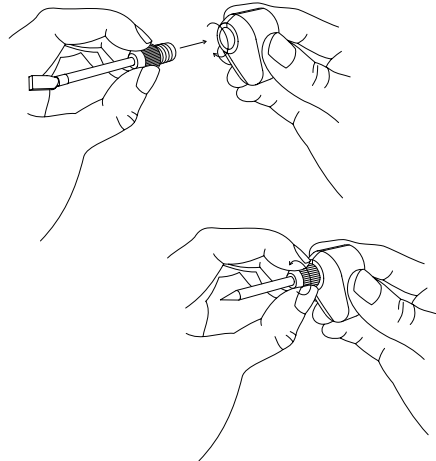

Soldering extension

After attaching the soldering extension and successfully completing the tutorial, select the desired temperature of the tip (0 - 100%; 100% $\approx 470^{\circ}\text{C}$ / 878°F) and turn on the tip heater by pressing the front button.

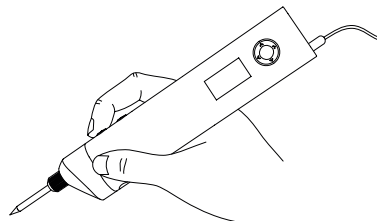

Maintenance

3D drawing attachment

Make sure the filament is not warped, has both ends cut off, and is not rolled up too tight.

Before completing the 3D drawing ALWAYS eject the filament completely out of the tool body, otherwise the nozzle may be damaged. Store filament in a closable bag.

In case of heavier soiling, the nozzle can be cleaned with paper towels when it is fully heated - CAUTION HOT!

Burning and soldering attachment

The accessory can be cleaned with towel paper, never use sharp, hard or abrasive tools!

This will damage the special layer on the surface and cause unwanted behaviour of extension.

In case of wear, the extensions can be replaced by spare parts, available in the 3Dsimo online store. Unscrew the extension counterclockwise. The tightening of the extension tip should be done with sensitivity and without use of tools.

Resistance wire cutting extension

Contamination of the wire can be removed with a paper towel.

If the resistance wire breaks, always use a new wire, available in the 3Dsimo online store.

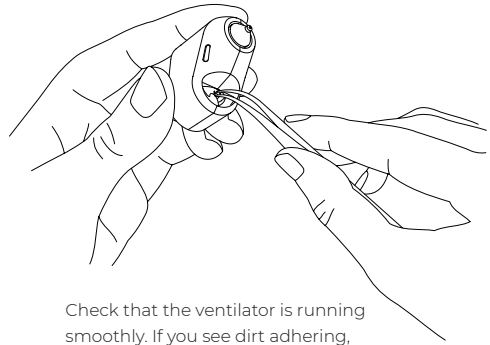

Check that the ventilator is running smoothly. If you see dirt adhering, remove it with tweezers.

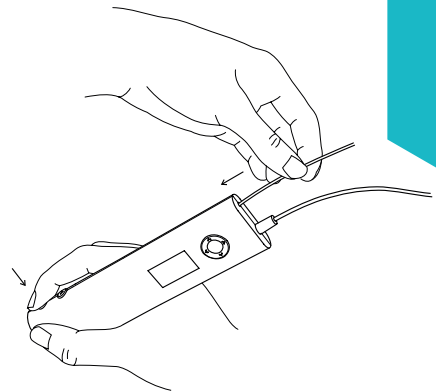

To remove filament residue, push another piece of filament through the body of the pen without the extension attached.

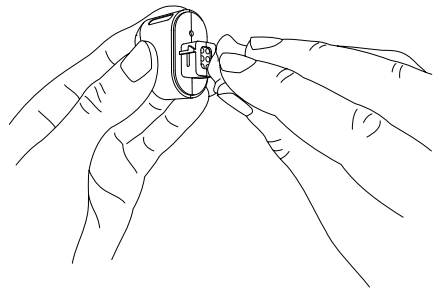

Gently clean the contacts of all attachments with a dry cloth.

Warning

Risk of burns - 3Dsimo accessories can reach temperatures up to 500 ° C, do not touch the nozzle, tips or resistance wire for a few minutes after use!

Never remove the 3D drawing extensions if it contains filament, it may cause irreparable damage to the nozzle or other components!

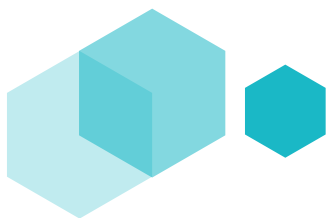

Avoid contact of volatile or flammable substances with 3Dsimo MultiPro accessories. Warn everybody around you that the extensions reach high temperatures and should not be touched. Allow the extensions to cool completely before putting them away. Otherwise, there is a risk of damage to the case and the accessory.

Always use the original 3Dsimo s.r.o. filament and accessories. Otherwise it may result in irreversible damage to the 3Dsimo MultiPro or other damage. The manufacturer is not responsible for damage caused by not following instructions.

This product is not a toy, use by children is only possible under adult supervision!

When storing, transporting and using the 3Dsimo MultiPro, keep the device and all its parts dry and avoid contact with liquids.

Do not disassemble 3Dsimo MultiPro or its parts under any circumstances, in case of a defect contact an authorized service center, or write to: **support@3dsimo.com**

Do not use the AC adapter if its cord is damaged. In this case there is a risk of electric shock.

Keep this information for future reference.

The manufacturer is not responsible for any damage caused by the use of this device in conflict with these operating instructions.





Specifications

Adapter

Input voltage: 100 – 240 V AC, 50/60 Hz

Output voltage: 12 V

Output power: 24 W

3Dsimo MultiPro

Input voltage: 12 – 24 V

Input current: 2 A

Noise: 21 – 30 dB



Certificates

This equipment complies with the European Directive on Registration, Evaluation, Authorization and Restriction of Chemicals (REACH) (Directive 1907/2006/ EC of the European Parliament and of the European Council) and the European Directive on the restriction of hazardous substances in electrical and electronic equipment (ROHS) 2002/95/EC of the European Parliament and of the European Council).

European Safety Standards - This device complies with European safety standards.



Complaints and customer support

The device is covered by a warranty period of 24 months.

In the event of a fault or breakdown, please contact: support@3dsimo.com

The original filaments and accessories are available here: eshop.3dsimo.com



You have a chance to win more 3Dsimo products!

Take a picture of your creating with our tool, post a photo on Instagram with the tag **#3dsimo** and you can win more great products. Once a month, we reward one customer with additional free products in value up to **150 USD**.



CZ: 3Dsimo MultiPro – 3D pero

Multifunkční nástroj – 3D kreslení, pájení, řezání a vypalování.
Pro více informací o vašem zařízení, navštivte prosím stránku: www.3dsimo.com
UPOZORNĚNÍ: Vlastní zařízení včetně barvy se může mírně lišit od tištěných obrázků.

⚠ **VAROVÁNÍ: Nebezpečí popálení! Po zahřátí tryska i hroty dosahují vysokých teplot!**

⚠ **VAROVÁNÍ: Nedotýkejte se trysky, hrotů, navazujících plastových částí ani roztaveného plastu vytékajícího z trysky - nebezpečí popálení**

Distributor: ConQuest entertainment a.s.,
Hloubětínská 11, 198 00 Praha 9, www.b2b.cq.e

Výrobce: 3Dsimo s.r.o, Kaprova 42/14,
11000 Praha 1, Česká Republika

V souladu s ASTM F963-96A



SK: 3Dsimo MultiPro – 3D pero

Multifunkčný nástroj – 3D kreslenie, spájkovanie, rezanie.
Pre viac informácií o vašom zariadení, navštívte prosím stránku: www.3dsimo.com
UPOZORNENIE: Vlastné zariadenie vrátane farby sa môže mierne líšiť od vytlačených obrázkov.

⚠ **VAROVANIE: Nebezpečie popálenia. Po zahriatí tryska aj hroty dosahujú vysoké teploty!**

⚠ **VAROVANIE: Nedotýkajte sa trysky, hrotov, nadväzujúcich plastových častí ani plastu vytékajúceho z trysky - nebezpečie popálenie.**

Dovozce: ConQuest Slovakia a.s., Rybníčná 40,
831 06 Bratislava, www.conquest.sk

Výrobca: 3Dsimo s.r.o, Kaprova 42/14,
11000 Praha 1, Česká Republika

V súlade s ASTM F963-96A



PL: 3Dsimo MultiPro – pióro 3D

Wielofunkcyjny urządzenie – malowanie 3D, lutowanie sięcie i wypalanie.
Po więcej informacji prosimy odwiedzić stronę: www.3dsimo.com
OSTRZEŻENIE: Urządzenie łącznie z barwą, może różnić się od tego na obrazkach.

⚠ **UWAGA: Niebezpieczeństwo poparzenia.
Po nagraniu dysza i końcówki mają wysoką temperaturę!**

⚠ **UWAGA: Nie dotykaj dyszy, końcówek, plastikowych części ani roztopionego plastiku z dyszy - niebezpieczeństwo poparzenia.**

Dystrybutor: ConQuest entertainment a.s.,
Hloubětínská 11, 198 00 Praha 9, www.b2b.cq.e

Producent: 3Dsimo s.r.o, Kaprova 42/14,
11000 Praha 1, Czech Republic

Zgodność z ASTM F963-96A



HU: 3Dsimo MultiPro – 3D toll

Multifunkciós eszköz – 3D rajzolás, forrasztás, vágás ellenállás u zal segítségével és étetés. További információkért, kérjük látogassa meg a következő weboldalt: www.3dsimo.com
FIGYELMEZTETÉS: A készülék valóságban és a képen látható színei és a kidolgozása kissé eltérhet.

⚠ **FIGYELMEZTETÉS: Égési sérülés veszélye. Felhevítés után a csővég és a hegyek magas hőmérsékletet érnek el!**

⚠ **Ne érintse meg a csővéget, a hegyet, a csatlakozó műanyag részeket és a csővégből kifolyó felolvasztott műanyagot sem - égési sérülés veszélye.**

Forgalmazó: ConQuest entertainment a.s.,
Hloubětínská 11, 198 00 Praha 9, www.b2b.cq.e

Cyártó: 3Dsimo s.r.o, Kaprova 42/14,
11000 Praha 1, Czech Republic

Megfelel a következő szabványnak ASTM F963-96A

